

KEY FEATURES

- Enclosed Medical Switching Power Supply
- Remote ON/OFF Function
- Standby 5V@1A
- High Efficiency up to 92%
- With P.F.C. Function >0.94
- Ultra Compact Size: 5.5 x 3.25 x 2.48 Inches
- 3-Year Product Warranty

ELECTRICAL SPECIFICATIONS

All specifications valid at normal input voltage, full load and +25°C after warm-up time unless otherwise stated.

Model No.	MQF500E-12S	MQF500E-24S	MQF500E-48S	
Max Output Wattage (W)	500 W			
Input	Voltage	90-264 VAC or 127-370 VDC		
	Frequency (Hz)	47-63 Hz		
	Current (Full load)	<6.3 A max. (115 VAC) / <3.15 A max. (230 VAC)		
	Inrush Current (<2ms) (Cold Start)	< 40 A max. (115 VAC) / < 80 A max. (230 VAC)		
	Leakage Current	< 0.1 mA max. (Input-Output)		
	Power Factor (at 230 VAC)	PF>0.94 at Full Load		
Output	Voltage (V.DC.)	12V	24V	48V
	Voltage Accuracy	±2%		
	Voltage Adj. Range (V.DC)	11.52~12.48	23.04~24.96	46.08~49.44
	Current (A) (max.)	41.5	20.8	10.41
	Line Regulation (115-264 VAC)	±0.5%		
	Load Regulation (10-100%) (typ.)	±1%		
	Minimum Load	3%		
	Maximum Capacitive Load	10,000µF	5,000µF	2,500µF
	Ripple & Noise (typ.)	160mV	240mV	480mV
	Efficiency (at 230 VAC)	89%	91%	92%
	Hold-up Time (at 115 VAC)	8 ms min.		
Protection	Over Power Protection	Auto recovery		
	Over Voltage Protection	Auto recovery		
	Overt Temperature Protection	Auto recovery		
	Short Circuit Protection	Auto recovery		
Isolation	Input-Output (V.AC)	4000VAC or 5656VDC		
	Input-PE (V.AC)	2000V		
	Output-PE (V.AC)	1500V		
Environment	Operating Temperature	-30°C...+70°C (with derating)		
	Storage Temperature	-35°C...+85°C		
	Temperature Coefficient	±0.03%/°C (0~50°C)		
		±0.06%/°C (-30~0°C)		
	Altitude During Operation	5000m		
	Humidity	95% RH		
	Atmospheric Pressure	56 kPa to 106 kPa		
	MTBF	>160,000 h @ 25°C (MIL-HDBK-217F)		
Vibration	10~500Hz, 2G 10min./1cycle, 60min. each along X, Y, Z axes.			

ELECTRICAL SPECIFICATIONS

All specifications valid at normal input voltage, full load and +25°C after warm-up time unless otherwise stated.

Model No.		MQF500E-12S	MQF500E-24S	MQF500E-48S
Physical	Dimension (L x W x H)	5.5 x 3.25 x 2.48 Inches (139.7 x 82.55 x 62.9 mm) Tolerance ±0.5 mm		
	Weight	690 g		
Safety	Approval	cUL / UL Standard: UL 60950-1, CAN/CSA C22.2 No. 60950-1-07 ANSI/AAMI ES60601-1 (2005 + C1:09 + A2:10), CAN/CSA-C22.2 No. 60601-1 (2008), 2 x MOPP		
EMC	Conducted and radiated EMI	EN55011 / EN55032 class B, Radiated Class A (EN60601-1-2 4th edition)		
	ESD	EN61000-4-2		
	Radiated Immunity	EN61000-4-3		
	Fast Transient	EN61000-4-4		
	Surge	EN61000-4-5		
	Conducted Immunity	EN61000-4-6		
	PFMF	EN61000-4-8		
	Dips & Interruption	EN61000-4-11		

NOTE

- This product is not designed for use in critical life support systems, equipment used in hazardous environment, nuclear control systems or other such applications which necessitate specific safety and regulatory standards other the ones listed in this datasheet.**
- Ripple & Noise are measured at 20MHz of bandwidth with ceramic 0.1uF & chemi-con KY 47uF parallel capacitor.

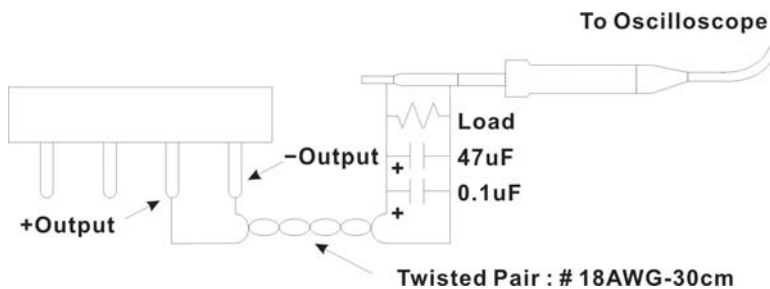

A 30cm twisted pair of no.18 AWG copper wire is connected to a 47uF and 0.1uF capacitor of proper polarity and voltage rating. The oscilloscope probe ground led should connect right to the ground ring of the probe and be as short as possible. The oscilloscope bandwidth should be at 20MHz and connected to AC ground.

- Hold-up Time measured at 90% Vout.
- Main Vout >3% Load, 12V (Aux) / 0.3A., 12V (Aux) need 0.1A Minimum Load, Auxiliary voltage output ground 10.2~13.3V
- Strongly recommend to conduct this test with DC Voltage. If customer wishes to test with AC Voltage, please disconnect all Y-Capacitors within Arch power supply.

DERATING

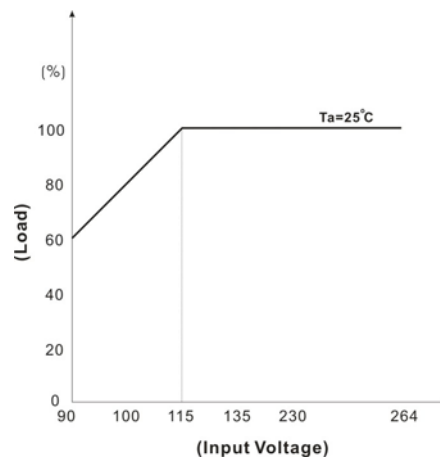
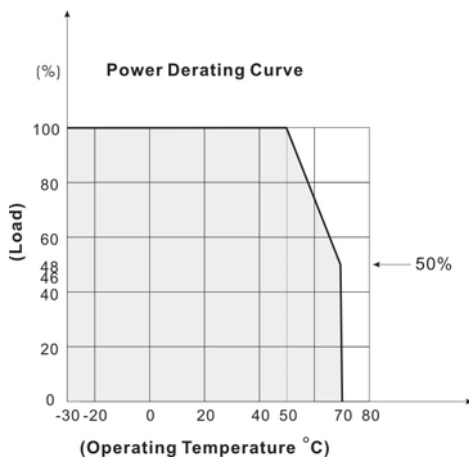

MECHANICAL DIMENSION (Top View)

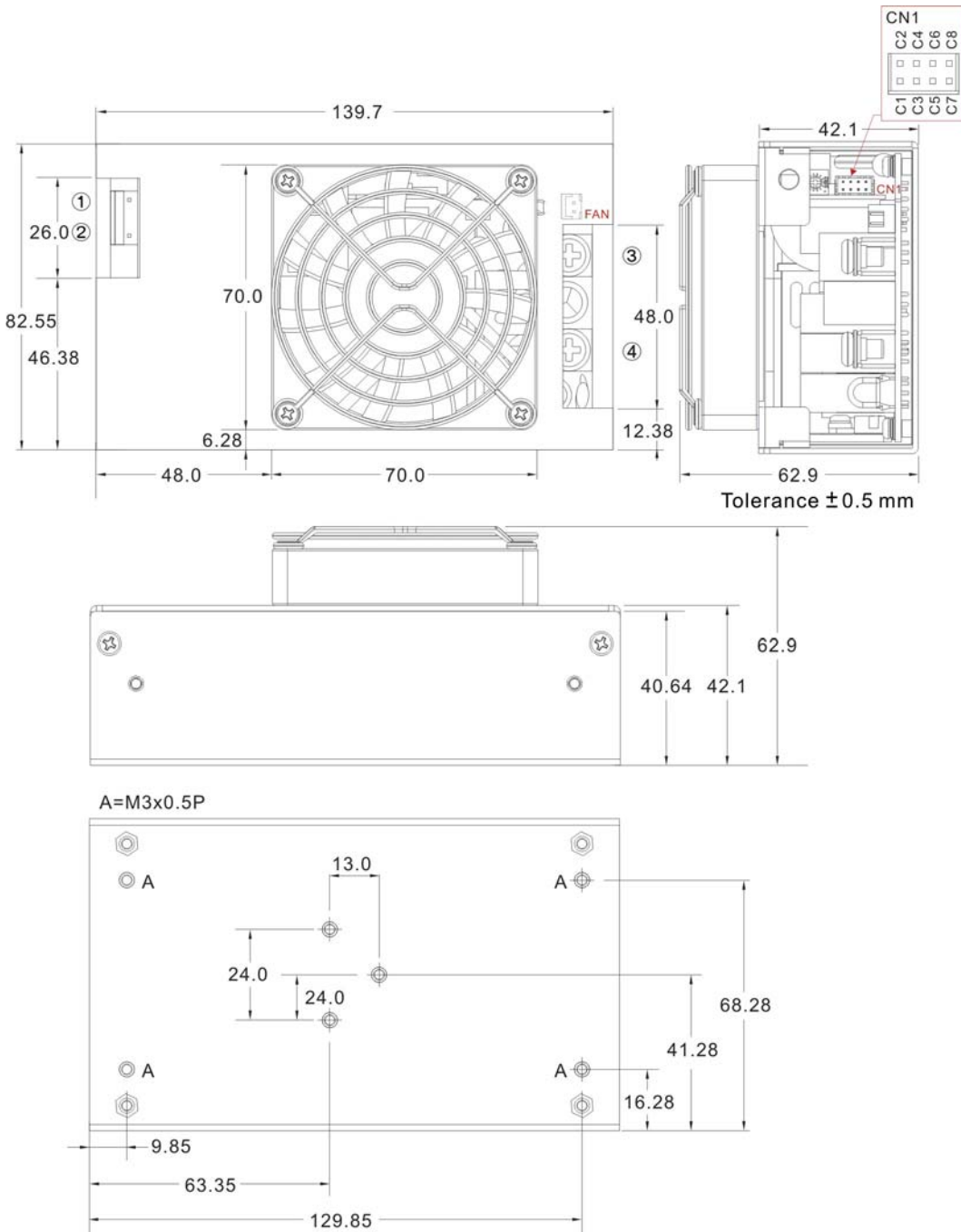

PIN#	Single
A	PE
1	AC IN (N)
2	AC IN (L)
3	+DC OUT
4	-DC OUT

Connector Pin (FAN)	
PIN#	Single
F1	+12V
F2	GND

Connector Pin (CN1)	
PIN#	Single
C1	-5VSB
C2	+5VSB
C3	GND
C4	DC OK
C5	-RC
C6	+RC
C7	-S
C8	+S

ASSEMBLY INSTRUCTIONS

*U Case T=2.5mm

Customer is advised to screw into the threads no more than 2.5mm

FUNCTION DESCRIPTION of CN1

Pin No.	Function	Description
C1	-5VSB	This pin connects to the negative terminal(-V). Return for DC-OK and -RC signal output.
C2	+5VSB	Stand by voltage output ground 4.2~5.5V, referenced to pin C1(-5VSB). The maximum load current is 1A with Fan, 0.4A without Fan..
C3	GND	This pin connects to the negative terminal(-V). Return for DC-OK and -RC signal output.
C4	DC OK	DC-OK Signal is a DC output, referenced to pin C3(DC-OK GND).
C5	-RC	This pin connects to the negative terminal(-V). Return for DC-OK and -RC signal output.
C6	+RC	Turns the output on and off by electrical or dry contact between pin C5 (-RC), Short: Power OFF, Open: Power ON.
C7	-S	Negative sensing. The -S signal should be connected to the negative terminal of the load. The -S and +S leads should be twisted in pair to minimize noise pick-up effect.
C8	+S	Positive sensing. The +S signal should be connected to the positive terminal of the load. The +S and -S leads should be twisted in pair to minimize noise pick-up effect.

FUNCTION MANUAL & APPLICATION NOTE
1. DC-OK Signal

Between DC-OK and GND	Output Status
3.7~6V	ON
0~1V	OFF

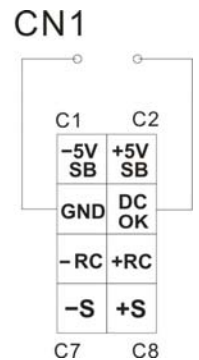
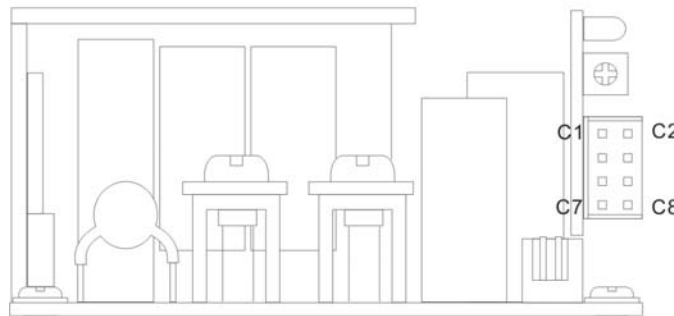
2. Remote Control

It can be turned ON/OFF by using the "Remote Control" function.

Between +RC and -RC	Output Status
SW ON (Short)	OFF
SW OFF (Open)	ON

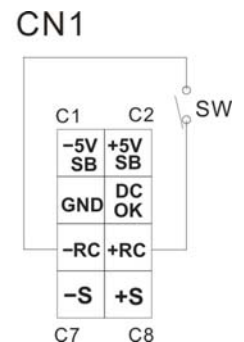
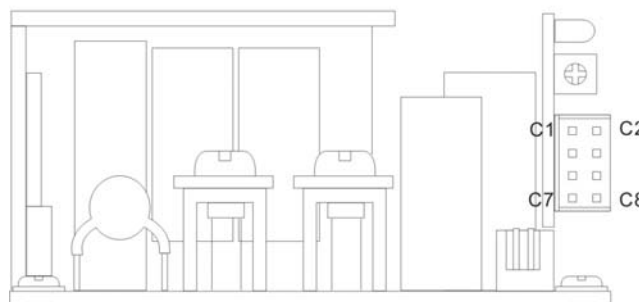
BLOCK DIAGRAM
