

KEY FEATURES

- Universal Input: 90-264 VAC
- With P.F.C. Function, PF>0.95
- Remote ON/OFF Function
- Current Share Function
- Power Good Function
- High Efficiency up to 90~93%
- Protections: Over Load / Over Voltage /
Over Temperature / Short Circuit
- High Power Density
- RoHS Compliant Design
- 3-Year Product Warranty



ELECTRICAL SPECIFICATIONS

All specifications valid at normal input voltage, full load and +25°C after warm-up time unless otherwise stated.

Model No.	AQF600-12S	AQF600-24S	AQF600-48S	AQF600-54S
Max Output Wattage (Convection) (W)	540W	600W	600W	600W
Input	Voltage			
	90-264 VAC or 120-370 VDC			
	Frequency (Hz)			
	47-63 Hz			
	Current (Full load)			
	< 8.0 A max. (115 VAC) / < 3.5 A max. (230 VAC)			
Inrush Current (<2ms)				
< 15 A max. (115 VAC) / < 30 A max. (230 VAC)				
Leakage Current				
< 3.5 mA max.(240VAC 63Hz)				
Power Factor				
PF>0.99 (115 VAC) / PF>0.95 (230 VAC) at Full Load				
Output	Voltage (V.DC.)			
	12V	24V	48V	54V
	Trim			
	±5%			
	Voltage Accuracy			
	±2%			
	Current (Convection) (A) max			
	45	25	12.5	11.1
	Line Regulation (LL-HL) (typ.)			
	±1%			
	Load Regulation (5-100%) (typ.)			
±1%				
Minimum Load				
1%				
Maximum Capacitive Load				
60,000 uF	50,000 uF	20,000 uF	10,000 uF	
Ripple & Noise (max.)				
< 1% Vout				
Efficiency (typ.)				
90%	92%	92%	93%	
Hold-up Time				
12 ms min.				
Protection	Over Power Protection			
	Auto recovery			
	Over Voltage Protection			
	Auto recovery			
Over Temperature				
Auto recovery				
Short Circuit Protection				
Latch off				
Isolation	Input-Output (V.AC)			
	3000VAC or 4242VDC			
	Input-FG (V.AC)			
1500V				
Output-FG (V.AC)				
500V				
Function	5V Stand by (18CFM FAN)			
	5VSB: 5V@0.6A ; Tolerance ±10% , Ripple & Noise: 100m Vp-p (max.)			
	DC OK Signal (Power Good)			
	Turn ON: 3.7~5.7V ; Turn OFF: 0~1V			
Remote Control				
+RC / -RC: Power ON=open ; Power OFF=short				
Current Share				
CN4:CS, +V, -V are connected mutually in parallel.				
Environment	Operating Temperature			
	-25°C...+70°C (with derating)			
	Storage Temperature			
	-25°C...+85°C			
	Temperature Coefficient			
	±0.03%/°C (0~50°C)			
Humidity				
95% RH				
MTBF				
>100,000 h @ 25°C (MIL-HDBK-217F)				
Vibration				
10~500Hz, 2G 10min./1cycle, 60min. each along X, Y, Z axes.				

ELECTRICAL SPECIFICATIONS

All specifications valid at normal input voltage, full load and +25°C after warm-up time unless otherwise stated.

Model No.	AQF600-12S	AQF600-24S	AQF600-48S	AQF600-54S
Physical	Dimension (L x W x H) 9.0 x 4.13 x 1.72 Inches (228.5 x 105.0 x 44.0 mm) Tolerance ±0.5 mm			
	Weight 1024±50 g			
	Cooling Integral fan			
Safety	Agency Approvals CE, UL60950-1			
EMC	EMI (Conducted & Radiated Emission) EN 55022 class B, Radiated Class A			
	EMS (Noise Immunity) EN 55024			
	Surge 1KV L-N, 2KV L N-FG			

NOTE

1. Ripple & Noise are measured at 20MHz of bandwidth with 0.1uF & 47uF parallel capacitor.
2. Strongly recommend to conduct this test with DC Voltage. If customer wishes to test with AC Voltage, please disconnect all Y-Capacitors within Arch power supply.

BLOCK DIAGRAM

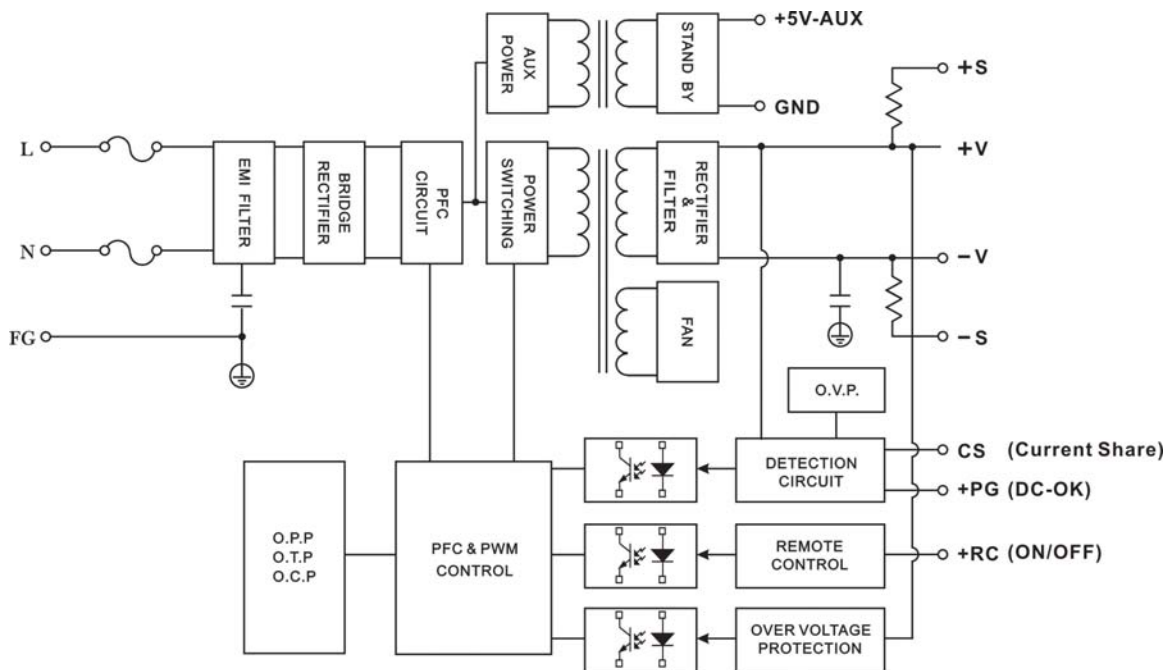

DERATING

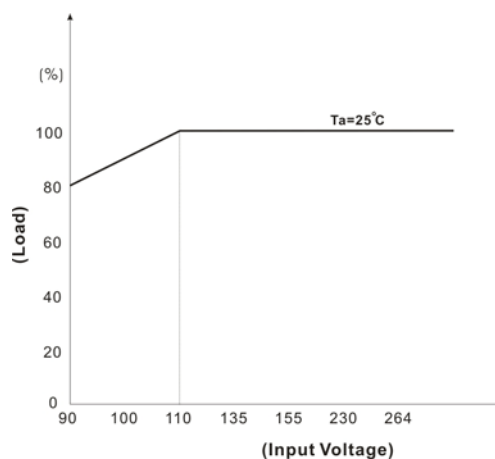
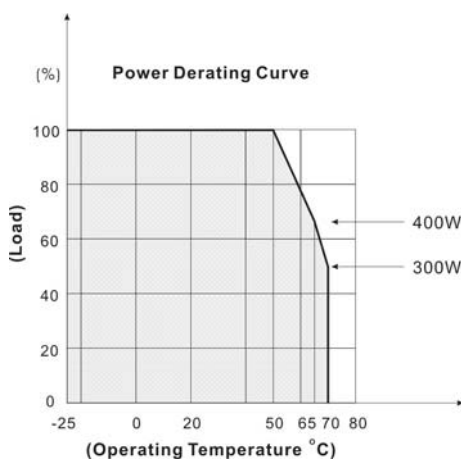

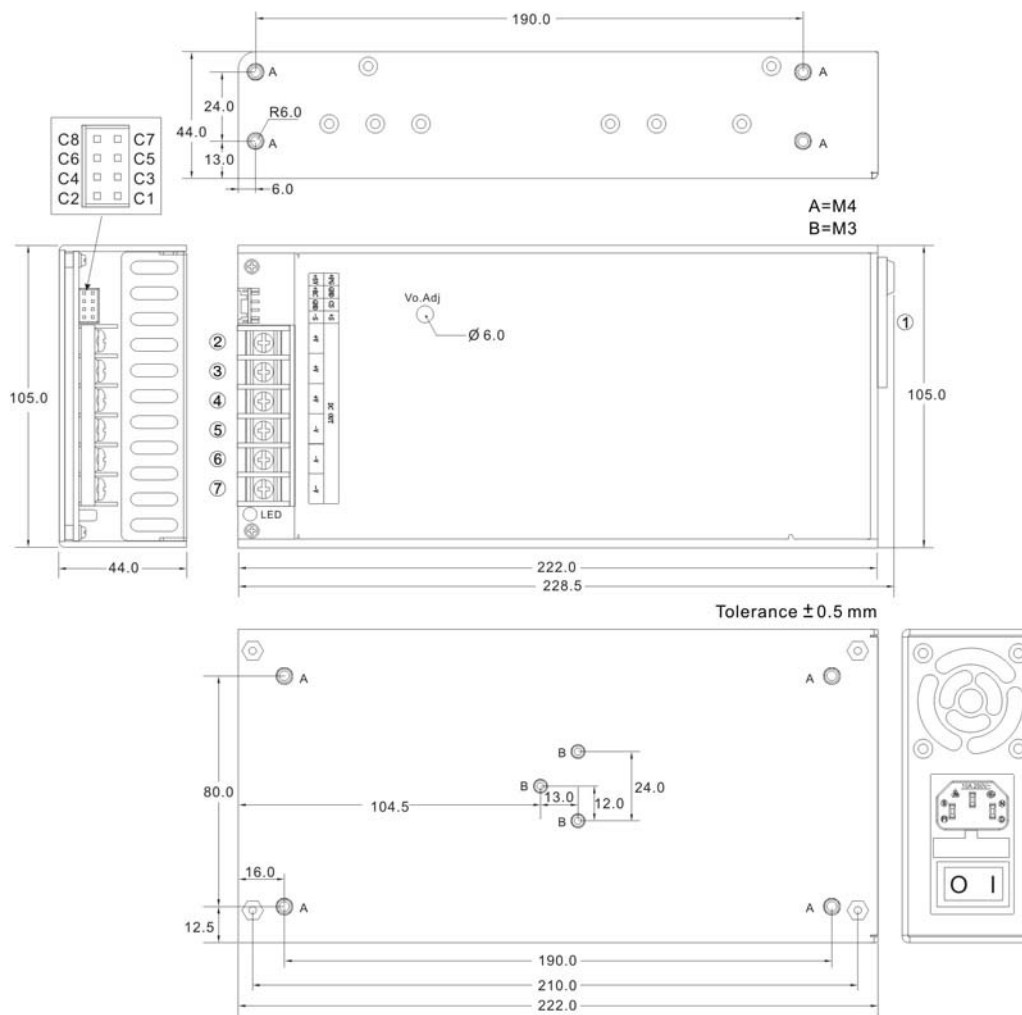
MECHANICAL DIMENSION

AC Input Terminal Pin

PIN#	Single
1	AC IN

DC Output Terminal Pin

PIN#	Single
2~4	+DC OUT
5~7	-DC OUT

Connector Pin (CN4)

PIN#	Single
C1	+S
C2	-S
C3	CS
C4	GND
C5	GND
C6	+RC
C7	+PG
C8	+5V-AUX

ASSEMBLY INSTRUCTIONS

*U Case T=2.0mm

Customer is advised to screw into the threads no more than 2.0mm

FUNCTION DESCRIPTION of CN4

Pin No.	Function	Description
C1	+S	Current Share Function Pin
C2	-S	
C3	CS	
C4	GND	This pin connects to the negative terminal(-V). Return for DC-OK signal output.
C5	GND	This pin connects to the negative terminal(-V). Return for DC-OK signal output.
C6	+RC	Turns the output on and off by electrical or dry contact between pin C4 (-RC), Short: Power OFF, Open: Power ON.
C7	+PG	DC-OK Signal is a DC output, referenced to pinC6(DC-OK GND).
C8	+5V-AUX	Stand by voltage output ground 4.5~5.5V, referenced to pin C4 or C5(GND). The maximum load current is 0.6A.

FUNCTION MANUAL & APPLICATION NOTE
1. DC-OK Signal

Between DC-OK(pinC5) and GND(pinC6)	Output Status
3.7~5.7V	ON
0~1V	OFF

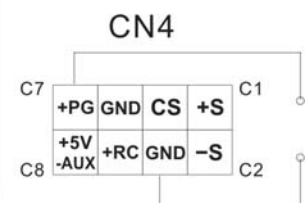
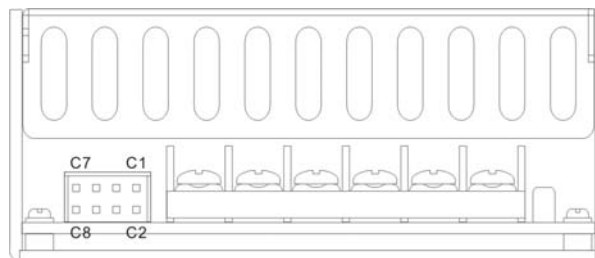

2. Remote Control

It can be turned ON/OFF by using the "Remote Control" function.

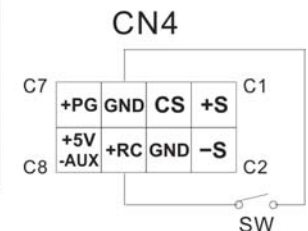
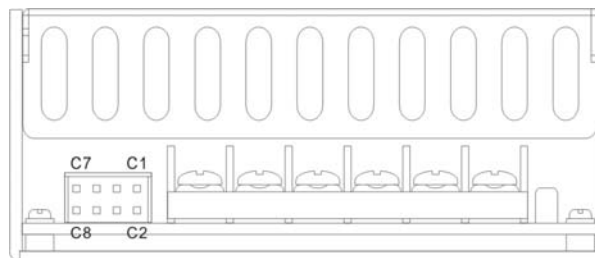
Between RC+(pinC3) and RC-(pinC4)	Output Status
SW ON (Short)	OFF
SW OFF (Open)	ON

3. Current Share

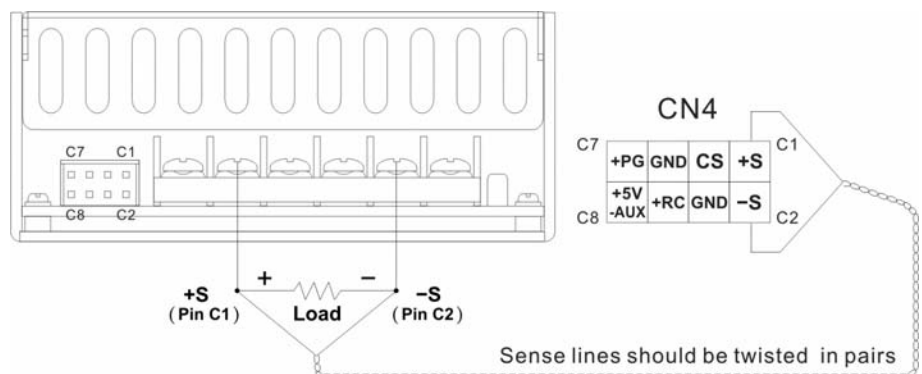
1. Difference in Vout among paralleled units should be less than +/-1%
2. Output Power at Parallel Operation = Rated Power per Unit x Number of Unit x 80%
3. Connect in parallel no more than 2 units. Please contact Arch for advice if more than 2 is needed.
4. Shorter wiring to each unit is recommended, as well as twisting +S and -S in pairs, as shown below
5. The remote sensing compensates voltage drop on the load wiring up to 5V



4. 1+1 Redundancy : sing 1 more AQF600 as the redundant unit

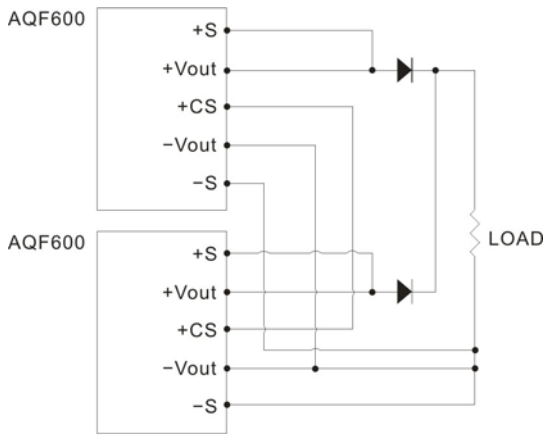

5. 1+N Redundancy: Using more AQF600 as the redundant units to increase the reliability

